

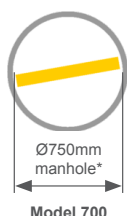

SUSPENDED CRADLE: ACCESUS BASIC CUBE

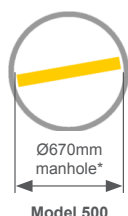
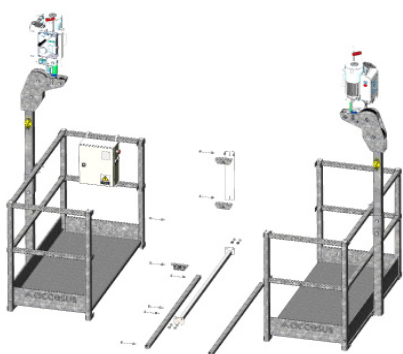
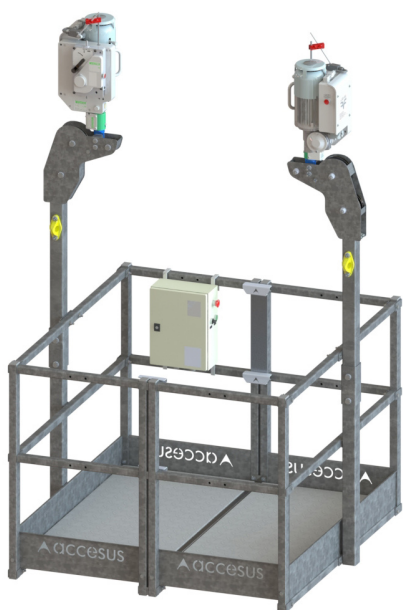

*Available for lower size manholes under request.

TECHNICAL INFO

Accesus Basic Cube suspended cradle designed for elevation of people and loads according to EN 1808 standards.

The *Accesus Basic Cube* suspended cradle is composed by steel and alu elements and it's available in different lengths of 0,8 - 1,2 - 1,6 m. The *Accesus Basic* cradle is lightweight, easy to assembly, store and transport. The assembly is made by nuts and bolts for a maximum safety.

Pieces of small size and fits into confined spaces like lifts, freight elevators, lightshafts, etc. It passes into Ø750mm manholes (maximum dimension of piece 730mm) and Ø670 (maximum dimension of piece 640mm) depending of model.

***Available upon request for lower size manholes.**

The equipment elements allows to configure a cradle in wide range of sizes from minimum 1x0,8m to maximum 1,4x1,6m modules.

The *Accesus Basic Cube* suspended cradle is equipped with two **e.lift®501 electric hoist** (load capacity 500kg) and two **over-speed safety device securichute®600** mounted on **double cable** with the maximum safety and features for lifting people.

The *Accesus Basic Cube* suspended cradle is compatible with all the ACCESUS suspension systems.

Other features:

- **Compatible** with a wide range of ACCESUS products.
- **Modular elements** from 0,70m² to 2,14m².
- **Detachable**, heaviest piece 15kg / 70cm.

SAFETY DEVICES

- **Main brake.**
- **Fall arrest device.**
- **Inclination device**, which blocks the descent of the platform.
- **Overload sensor.**
- **Suspension & secondary wire ropes.**
- **Safety coefficient** of the wire ropes.
- **Handrails** with 1m of height.
- **Anchoring point** acc. to EN795.

TECHNICAL FEATURES

<i>ACCESUS BASIC CUBE</i> suspended cradle	
Working load limit	240kg
Working maximum height	Ilimitada
Maximum size of the cradle	2,14m ²
Minimum size of the cradle	0,70m ²
Height of the handrail	1m
Detachable for manholes	Ø0,67m

COMPOSITION

Description of the elements	Configurations					
	1			1,4		
Cradle width (m)	0,8	1,2	1,6	0,8	1,2	1,6
0,5x0,8m floor panel	2	0	0	0	0	0
0,5x1,2m floor panel	0	2	0	0	0	0
0,5x1,6m floor panel	0	0	2	0	0	0
0,7x0,8m floor panel	0	0	0	2	0	0
0,7x1,2m floor panel	0	0	0	0	2	0
0,7x1,6m floor panel	0	0	0	0	0	2
Stirrup (upper part)	2	2	2	2	2	2
Stirrup (lower part)	2	2	2	2	2	2
End panel 0,5m	4	4	4	0	0	0
End panel 0,8m	0	0	0	4	4	4
0,8m side panel	2	0	0	2	0	0
1,2m side panel	0	2	0	0	2	0
1,6m side panel	0	0	2	0	0	2
0,8m handrail	4	0	0	4	0	0
1,2m handrail	0	4	0	0	4	0
1,6m handrail	0	0	4	0	0	4
<i>Union Basic</i> floor 0,8m	1	0	0	1	0	0
<i>Union Basic</i> floor 1,2m	0	1	0	0	1	0
<i>Union Basic</i> floor 1,6m	0	0	1	0	0	1
<i>Union Basic</i> end floor	2	2	2	2	2	2
<i>Union Basic</i> end panels	4	4	4	4	4	4
<i>Union Basic</i> nameplate	1	1	1	1	1	1

Description of the elements

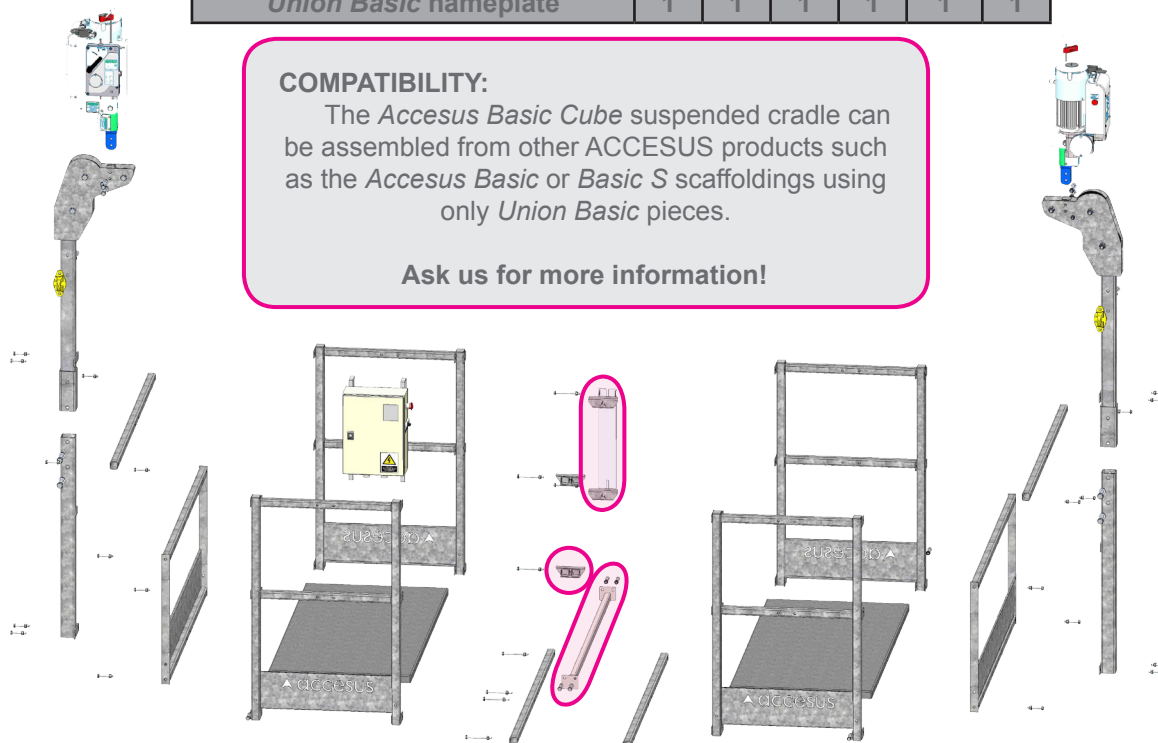

COMPATIBILITY:
The *Accessus Basic Cube* suspended cradle can be assembled from other ACCESUS products such as the *Accessus Basic* or *Basic S* scaffoldings using only *Union Basic* pieces.

Ask us for more information!



**SUSPENDED CRADLE:
ACCESUS BASIC CUBE**

CONFIGURATIONS

Configurations	Configurations					
	1			1,4		
Cradle width (m)						
Cradle length (m)	0,8	1,2	1,6	0,8	1,2	1,6
Working load limit (kg)	240	240	240	240	240	240
Number of people	2	2	2	2	2	2

AVAILABLE WIDTH

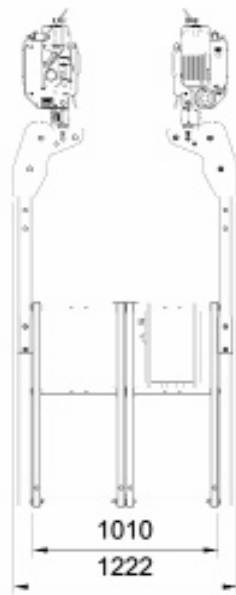

Model 500

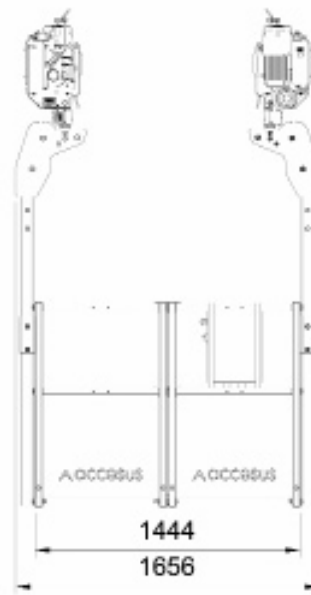

Model 700

AVAILABLE LENGTH

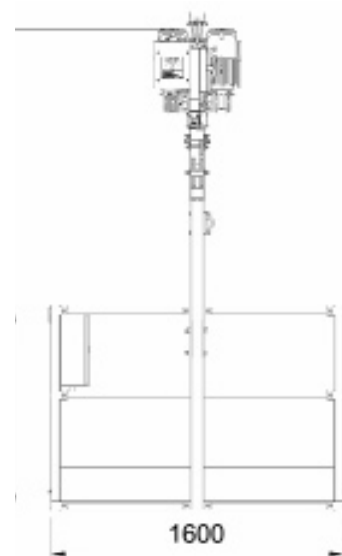
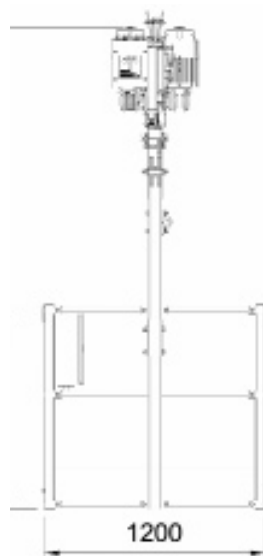
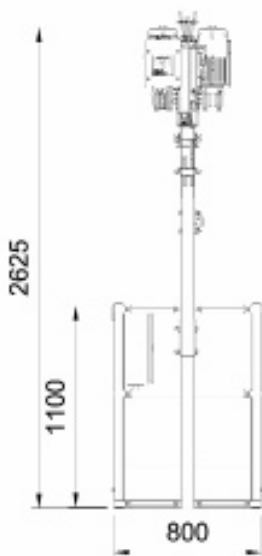



**SUSPENDED CRADLE:
ACCESUS BASIC CUBE**

CONFIGURATIONS

Common characteristics for all configurations:

- Working load limit: **240kg.**
- Maximum people: **2 persons.**
- Heaviest piece: 15kg.

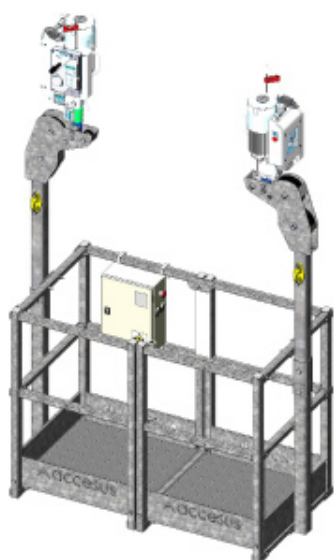

**Width 1,4m
Length 0,8m
Weight 242kg**

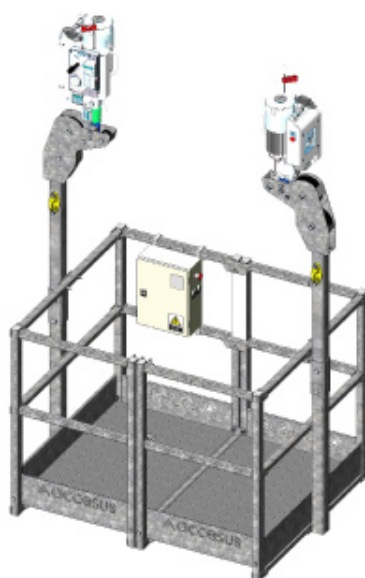

**Width 1,4m
Length 1,2m
Weight 262kg**

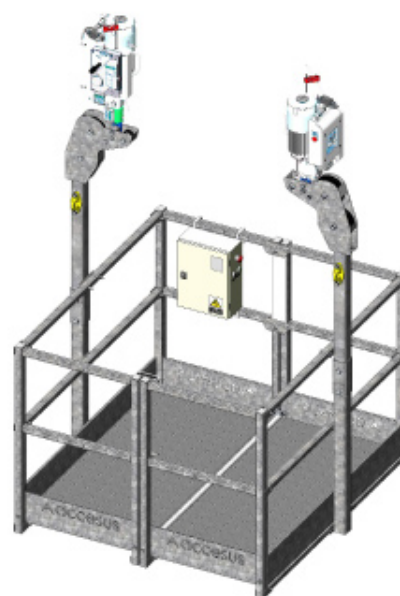

**Width 1,4m
Length 1,6m
Weight 281kg**

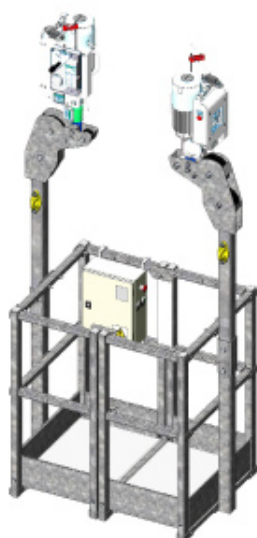

**Width 1m
Length 0,8m
Weight 232kg**

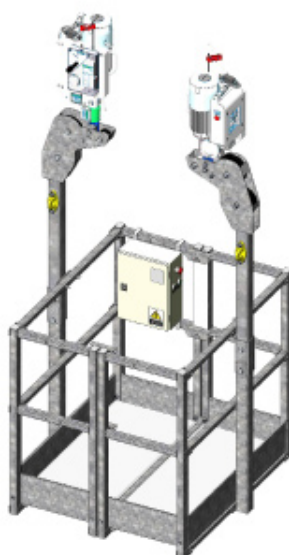

**Width 1m
Length 1,2m
Weight 250kg**

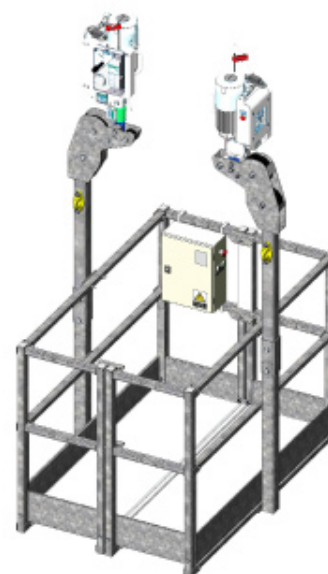

**Width 1m
Length 1,6m
Weight 267kg**



SUSPENDED CRADLE:
ACCESUS BASIC CUBE

